

User's Guide



HeatStation 5000R2

Induction Heating System



MAGNEFORCE

155 Shaffer Drive N.E.
Warren, OH 44484
330-856-9300
www.magneforce.com

CONTENTS

1. Introduction	
1.1 HeatStation 5000R2 System	1
1.2 What is Induction Heating?	1
2. Safety	
2.1 General Safety Information	2
2.2 Electromagnetic Radiation	3
2.3 FCC Precautionary Statement	3
2.4 Other Regulatory Statements	3
3. System Components	
3.1 HS5000R2 Induction Power Supply	4
3.2 Heating Coils	5,6
3.3 Output Transformer	7
3.4 Control Units	7
3.5 Coolant Source	8
4. Setup	
4.1 Locate and Mount the Power Supply	9
4.2 Locate and mount the Output Transformer	9
4.3 Attach the Heating Coil	10
4.4 Hookup the Coolant Source	11
4.4.1 Recommended Coolant	12
4.5 Select the Source for Power Control	13
4.6 Attach the Control Unit	13
4.6.1 Auxiliary Control Cable	14
4.6.1.1 On/Off Control (HS5000R2)	14
4.6.1.2 On/Off Control (HS5000R2C)	14
4.6.1.3 Vdc Output Indicator	14
4.6.1.4 Relay Output Verification	15
4.6.1.5 Heating Power Control (HS5000R2)	15
4.6.2 On/Off Pushbutton Station	15
4.6.3 Twin On/Off Footswitch	16
4.6.4 Power Control Footpedal	16
4.6.5 Timer/Power Control (HS5000R2)	16
4.7 Connect Incoming Power	17
4.7.1 HS5000R2 Power Supply	17
4.7.2 Dynaflux Coolant Systems	17
5. Operation	
5.1 Turn on the Coolant Source	18
5.2 Turn on the Power Supply	18
5.3 Set the Power Level and Cycle Time	19
5.3.1 HS5000R2 Power Supply	19
5.3.2 HS5000R2C Power Supply	20
5.4 Set Remote On/Off and Timer 2 On/Off (HS5000R2C)	21
5.5 Fixture the Part in the Heating Coil	22

CONTENTS

5.6 Start Heating	
5.6.1 HS5000R2 Power Supply	23
5.6.2 HS5000R2C Power Supply	
5.7 Control Panel Indicator LED's	
5.7.1 Coolant LED (yellow)	24
5.7.2 Fault LED (red)	24
5.7.3 Load LED (green)	24
5.7.4 Heating LED (green)	24
6. Operating Precautions	
6.1 Heating Coils	
6.1.1 Attach the Heating Coil Correctly	25
6.1.2 Make sure Terminal Blocks are Clean	25
6.1.3 Heating Coil Insulation	26
6.1.4 Using non-Magneforce coils	26
6.2 Precautions when Heating a Part	
6.2.1 Make sure a Part is in the Coil	26
6.2.2 Do not Remove Part During Heating	26
6.2.3 Don't let the Part Touch the COil	26
6.2.4 Don't let Flux Build up Around the Coil	26
7. Recommended Maintenance	
7.1 Clean the Air Filters on the Power Supply	27
7.2 Check and Refill Coolant	27
7.3 Clean Transformer and Coil Terminal Blocks	27
7.4 Inspect the Heating Coils	27
8. Appendix	
8.1 HS5000R2 Exterior Components	28
8.2 HS5000R2 Interior Components	29
8.3 General Power Schematic	30
8.4 Control Wiring	31
8.5 Parts List	32
8.6 Coolant FLOW Schematic	33
8.7 HS5000R2 Power Supply Dimensions	34
8.8 HS5000R2 Output Transformer Dimensions	34
9. Warranty	35

1. INTRODUCTION

1.1 HeatStation 5000R2 System

The HeatStation 5000R2 induction heating system is a versatile, compact heat source that provides a fast and controllable method of heating a wide variety of parts and assemblies. A typical HeatStation 5000R2 system consists of the power supply, high frequency output transformer and heating coil. The output transformer connects to the power supply using a flexible power cable, allowing it to be located remote from the power supply and incorporated into semi-automatic or automatic processing fixtures.

The systems are easy to set up and use. A wide variety of available heating coils allow the system to be customized for many applications, including brazing, soldering, melting, annealing, degassing, adhesive curing and others. The HeatStation 5000R2 is easily adapted for manual or automatic operations. The clean, even heat results in high quality, repeatable part processing.

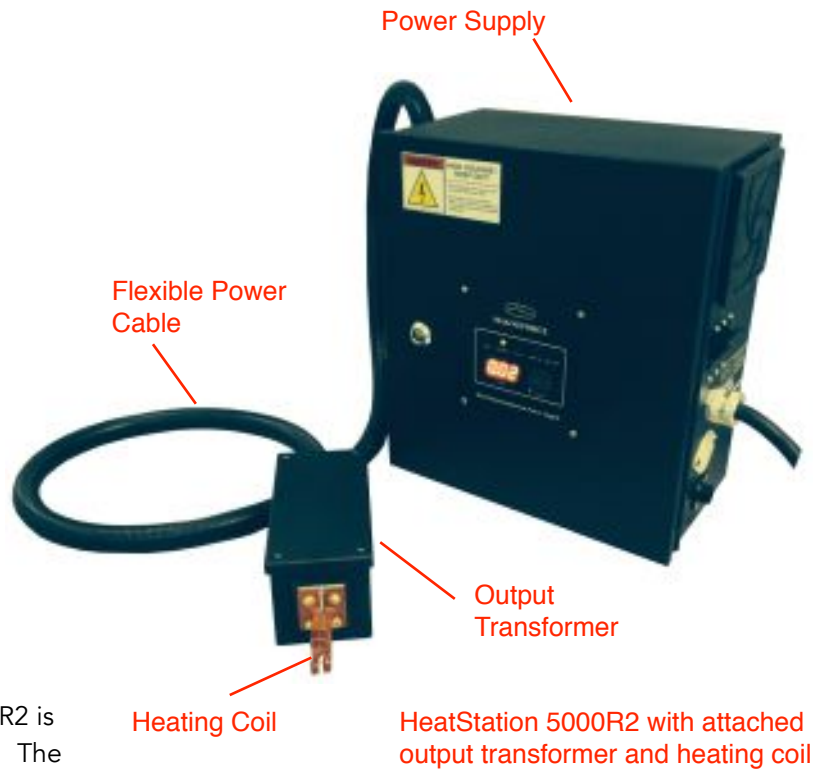

1.2 What is Induction Heating?

Induction heating is a method of heating electrically conductive materials in an electromagnetic field. The heating is rapid, flameless and non-contact. It will not affect plastic or other non-metallic materials. Heating can be controlled very reliably from part to part. The heating zone can be focused onto a specific area of the part by customizing the design of the heating coil.

The basic components of an induction heating system are a high frequency AC power supply, a heating coil and the workpiece. Most HeatStation systems also employ a high frequency output transformer to match the heating coil to the power supply. The power supply takes standard wall current and converts it to a 20-50 Khz high amperage output that flows through the transformer and heating coil and generates an electromagnetic field. When a workpiece is placed inside the coil, this field "cuts" through it and induces a flow of electric current in the part. The resistance of the part to this flow of current causes it to heat.



A fitting is brazed to a pipe with a solenoid coil

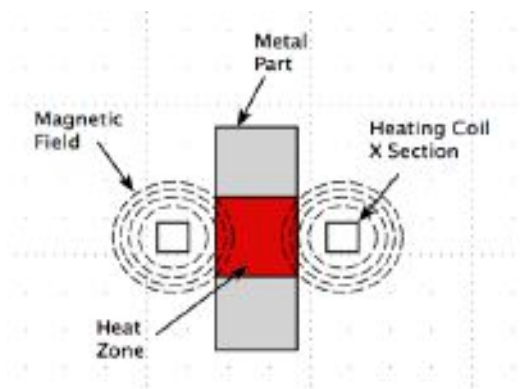

2. SAFETY

2.1 GENERAL SAFETY INFORMATION

HeatStation systems are safe to operate when used according to instruction. With any piece of electrical equipment, however, there are certain precautions and safety procedures that must be followed. These include:

1. Read and understand all parts of this User Guide before operating the system.
2. **HIGH VOLTAGE INSIDE!** The power supply and the output transformer enclosure should not be opened or serviced except by trained and qualified personnel.
3. The power supply must be plugged into a properly grounded outlet.
4. When the power supply is turned on, **HIGH VOLTAGE (300-350VDC)** is present inside the enclosure and at the interior power terminals inside the output transformer. When the power supply is turned off this voltage is still present! It takes about 2 minutes for this voltage to be drained by internal bleeder resistors after it is turned off. Never open the enclosure for at least five minutes after shutting off and disconnecting power to the system.
5. Always turn power off before changing the heating coil.
6. **CAUTION! POSSIBLE SHOCK HAZARD!** The heating coil is isolated from the electrical output of the power supply by the output transformer. When the power supply is turned on but is not heating, there is no current flow through the heating coil. When the system is heating electrical current flows through the heating coil. If the coil is not properly insulated or if the insulation is damaged it is possible to get shocked by contacting bare copper on the coil. **DO NOT** touch the heating coil when the system is heating! **DO NOT** use metal tools that may touch the heating coil when the system is heating! If a shock is reported, immediately shut down the equipment and inspect the heating coil for damage.
6. **DO NOT USE** heating coils that are not properly insulated or are damaged. **ALL** heating coils must be properly insulated and should be periodically inspected.
7. Always wear eye protection when operating the system.
8. **HOT PARTS!** Wear Gloves! Parts can heat up very rapidly to very high temperatures
9. **DO NOT** wear rings or jewelry when operating this equipment.
10. Locate the system in a safe environment. Do not use in a damp, wet or excessively dusty location.
11. Always turn off the system when not in use.

2. SAFETY

2.2 ELECTROMAGNETIC RADIATION

HeatStation systems generate a high frequency 20 to 50 Khz alternating magnetic field during operation. This magnetic field is concentrated at the heating coil and the part being heated. The strength of the field drops off rapidly as the distance from the coil decreases.

At this time, there is no information or evidence indicating that a magnetic field of the strength and frequency used with HeatStation systems has any adverse health effects. It is important, however, that all users of this equipment are aware of any possible hazard. As additional information becomes available, we will provide it to our customers as required.

It is recommended that individuals with pacemakers or similar devices do not operate HeatStation systems

2.3 FCC PRECAUTIONARY STATEMENT

HeatStation systems generate radio frequency energy and are subject to verification testing per FCC 47 CFR Part 18 for Industrial, Scientific and Medical equipment. Under certain conditions, they may cause interference with radio or television reception. If this equipment does cause interference to radio and television reception, which can be determined by turning the equipment off and on, the user is encouraged to try and correct the interference by one or more of the following measures.

- Reorient or relocate the receiving antenna.
- Increase the separation between the equipment and receiver.
- Connect the equipment into an outlet on a different circuit from that to which the receiver is connected.
- Consult an experienced technician for help

2.4 OTHER REGULATORY STATEMENTS

1. Metal rings and bracelets shall not be worn near strong electromagnetic fields of medium and high frequencies. (e.g. in the vicinity of the heating coils).

2. Strong electromagnetic fields may create a hazard to persons with metallic implants, artificial pacemakers and other similar items. Appropriate safety measures are to be applied in compliance with relevant local safety at work regulations.

3. HeatStation induction heating systems are classified as Group 2 Class A equipment. This includes all ISM RF equipment in which radio frequency energy in the frequency range 9Khz to 400Ghz is intentionally generated and used or only used, in the form of electromagnetic radiation, inductive or capacitive coupling, for the treatment of material or inspection/analysis purposes.

Class A equipment is suitable for use in all establishments other than domestic and those directly connected to a low voltage power supply network which supplies buildings used for domestic purposes.

3. SYSTEM COMPONENTS

A standard HS5000R2 heating system consists of the following components:

- 3.1. HS5000R2 or HS5000R2C high frequency induction power supply
- 3.2. Heating coil
- 3.3. High frequency output transformer
- 3.4. Control Unit (optional for HS5000R2C)
- 3.5. Coolant Source

3.1. HS5000R2 INDUCTION POWER SUPPLY

The HS5000R2 induction power supply is the primary component of the system. Its' function is to convert 50/60Hz line power to a high frequency, high amperage output and to deliver this power to the heating coil and the part being heated. The HS5000R2 operates at a maximum power level of 5000 watts on 208-240V 50/60Hz three phase power. (Single phase operation is available.)

The power supply is a 100% solid state AC/DC/AC inverter, operating at a resonant frequency of 20-50 Khz. The actual operating frequency is dependent on the design of the heating coil, the turns ratio of the output transformer and the internal capacitance of the power supply.

The HS5000R2 power supply is available in two models. The standard HS5000R2 incorporates a basic control panel that includes status indicator lights, power control knob and output power KW display. This version is typically used in conjunction with a user supplied PLC or where a timed cycle is not required. The HS50 00R2C incorporates an enhanced control panel that includes two 0-999.9S timers with LED displays, 2 power control knobs, one for each time setting, status indicator lights, output power KW display and ON/OFF pushbuttons. It is typically used in stand alone applications where a timed cycle is required.



HS5000R2 Power Supply



HS5000R2C Power Supply

3. SYSTEM COMPONENTS

3.1. HS5000R2 INDUCTION POWER SUPPLY (cont'd)

Some of the standard features of the HS5000R2 include:

- 5000 watt water cooled high frequency induction power supply
- 15.5" high x 15" wide x 7.5" deep power supply enclosure
- 7.25" long x 3.62" wide x 3.5" high output transformer enclosure
- Power control knob, LED output power display, status indicator lights
- Dual digital LED timers with dual power control, ON/OFF buttons (Model HS5000R2C only)
- Local or remote controlled operation
- Compact output transformer easily adapts to all types of processing fixtures
- Standard 6' long flexible power output cable.
- Output power verification circuitry
- Adjustable load sensor circuit to check for presence of part in heating coil
- Operates in resonance, no need to "ring up" to power
- Power tracking circuitry delivers constant power even with plant voltage fluctuation
- On/Off fast trip circuit breaker
- Integral Flow Transducer to prevent overheating

3.2. HEATING COILS

The heating coil is used to concentrate the high frequency magnetic field around the part that is to be heated. The coils are typically constructed from copper tubing and are water cooled during use. The water cooling is necessary because the high amperage output of the power supply and transformer would cause the coils to heat up very rapidly without proper cooling.

The coils attach to the front of the output transformer using four 10-24 x 1/2 brass screws with washers. This connection provides the electrical hookup and the coolant hookup. The coil terminals must be kept clean in order to maintain a stable, leak free connection.

The heating coils can be made in a wide variety of shapes and sizes in order to optimize heating of the part. Proper design and configuration of the coil is critical for efficient part heating. There are three basic types of coils. These include round (solenoid) shaped coils, channel or "C" shaped coils and the flat, pancake coil. The solenoid coil is the most efficient and should be used where possible.

Some heating coils do not require an output transformer. These coils are usually larger in size and do not require the heat to be focused in a small area. Coils of this type are referred to as inductors. They have a high inductance and connect directly to the power supply. These coils can either be air cooled or water cooled depending on the application.

Examples of different types of coils are shown on the following page.

3. SYSTEM COMPONENTS

3.2. HEATING COILS (cont'd)



Standard 2 turn round solenoid type coil for annealing a section on a shaft. Insulated with epoxy powder coat.



A 2 turn flat pancake type coil for heating an isolated spot on a steel strip. Insulated with red epoxy powder coat.



A "C" shaped coil allows a section of a long shaft to be easily inserted in the coil for a carbide insert brazing application. Coil head is plasma sprayed ceramic.



A 2 turn solenoid coil with mounting tab and formed slot to allow for a fin on the part. This coil is ceramic coated and fitting with optional quick change power terminals.

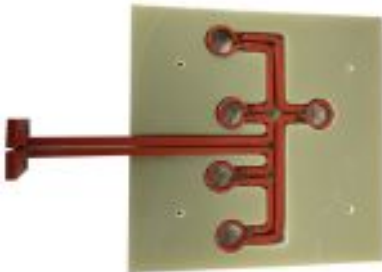

5 head coil for heating brass inserts prior to pressing in a plastic part. Coil is encased in a phenolic housing for mounting and to prevent it from mechanical damage.



Multiturn coil encapsulated in epoxy. This coil is used to heat and expand a motor housing for assembly.



A specialty inductor encased in a phenolic housing to heat a large round cylinder. This inductor connects directly to the power supply and does not require an output transformer.



Pneumatically operated split coil for soldering a large fitting to a coaxial cable. The two halves of the coil open and close to allow insertion of the fitting and to provide even heat around the circular connector body.

3. SYSTEM COMPONENTS

3.3. OUTPUT TRANSFORMER

The output transformer is a special high frequency step down transformer that is used to match the heating coil to the power supply via a 6' long power cable. The flexible cable allows the transformer and heating coil to be located remotely from the power supply and attached to any processing fixture as required. The heating coil attaches to the terminal blocks on the front of the output transformer.

The output transformers for the HS5000R2 heating system are available in a variety of turn ratios. Standard ratios are 5, 6, 7 and 8 turns. These ratios enable the use of almost any size heating coil. In general, the lower the number of turns on the transformer, the larger the heating coil that can be used.

It is important to note that not all heating coils can be used with all transformers. One of the primary functions of the output transformer is to provide the electrical inductance that is need to tune the resonant output frequency of the power supply. Certain coil/transformer combinations (e.g. a very small coil on a 5 turn output transformer) will allow the frequency to run outside of acceptable parameters and may cause damage to the equipment.



HS5000R2 Output Transformer

3.4. CONTROL UNITS

3. SYSTEM COMPONENTS

3.5. COOLANT SOURCE

All HeatStation 5000R2 systems require water cooling. The power supply, output transformer and heating coil must be water cooled. The coolant source can be supplied by the customer or commercially available water recirculating or chiller systems can be used. Magneforce Inc. recommends Dynaflux water recirculating coolant systems. The model used is either the Dynaflux R1100V or Dynaflux R2200V, depending on the application. These units offer flow rates, output pressures and heat removal capabilities that are satisfactory for most heating applications.

All fittings and tubings required for connection of the coolant source to the power supply are included with the units.



R1100V Coolant System



R2200V Coolant System

Magneforce also recommends the use of a sediment water filter with the coolant source to minimize buildup of particulate matter in the system over time. This buildup could affect the coolant flow and in severe cases prevent operation of the equipment. The water filter typically used is shown although most standard types of filters are acceptable.



Coolant Filter

4. SETUP

HeatStation H5000R2 heating systems are easy to set up and use. All items required for setup are included with the system. The steps required include:

- 4.1. Locate and mount the power supply in a suitable location.
- 4.2. Locate and mount the output transformer.
- 4.3. Attach the heating coil
- 4.4. Hookup the coolant source
- 4.5. Select the source for power control
- 4.6. Attach the control unit (if required)
- 4.7. Connect incoming power

4.1. LOCATE AND MOUNT THE POWER SUPPLY

The power supply is housed in a steel enclosure. The enclosure sits on 4 rubber feet attached to the bottom of the cabinet using 1/4-20 x 1/2 socket head screws. These feet can be removed to attach the cabinet directly to a fixture or frame. Also included with the power supply are a set of top and bottom flanges which screw to the back of the enclosure. These flanges can be used to hang the power supply on a frame or a wall. Dimensions are given in the appendix of this manual. Dimensions for the mounting feet and bracket are shown in the appendix of this user guide.

The cooling fan is located on the right side of the power supply. At least 4 inches of space should be provided at the right side of the enclosure to permit air flow. The power supply should be mounted only in a clean, dry location.

It is usually best to locate the power supply a few feet away from the output transformer and heating coil. This will prevent possible damage to the power supply from fume, flux and other effects of the heating process.

4.2. LOCATE AND MOUNT THE OUTPUT TRANSFORMER

The output transformer is also supplied with 4 rubber feet mounted to the underside of the transformer enclosure using four 8-32 x 1/2 screws. These feet can be removed to attach the transformer directly to a fixture or table top. Dimensions are given in the appendix at the end of this user guide. If possible, the transformer and coil should be positioned above the coolant source. This will minimize the amount of coolant that leaks out when a coil is changed.

4. SETUP

4.3. ATTACH THE HEATING COIL

The heating coil attaches to the terminal blocks on the front of the output transformer. The procedure is as follows:

- Make sure that the terminal blocks on the base of the coil and the face of the output transformer are clean.
- Insert the supplied "O" rings into the counterbores on the output transformer terminal blocks. Note: The "O" rings are 3/16" ID 5/16" OD neoprene or buna-n rubber.
- Position the heating coil terminal blocks over the output transformer terminal blocks.
- Fasten the coil using the 10-24 x 1/2 brass screws and washers supplied. Make sure to use the washers as the insertion depth of the mounting hole is limited. DO NOT USE steel screws or screws longer than 1/2".
- Tighten the screws down evenly. The coil blocks must make even contact with the transformer blocks for proper system operation.

Note:

- The coil blocks must be securely attached to the output transformer terminal blocks. If they are not this could result in blowing the system fuse when first initiating heating.
- The coil blocks and the blocks on the front of the output transformer **must** be kept clean.
- **DO NOT** use steel screws or screws that are longer than 1/2". (Stainless steel screws are OK.)

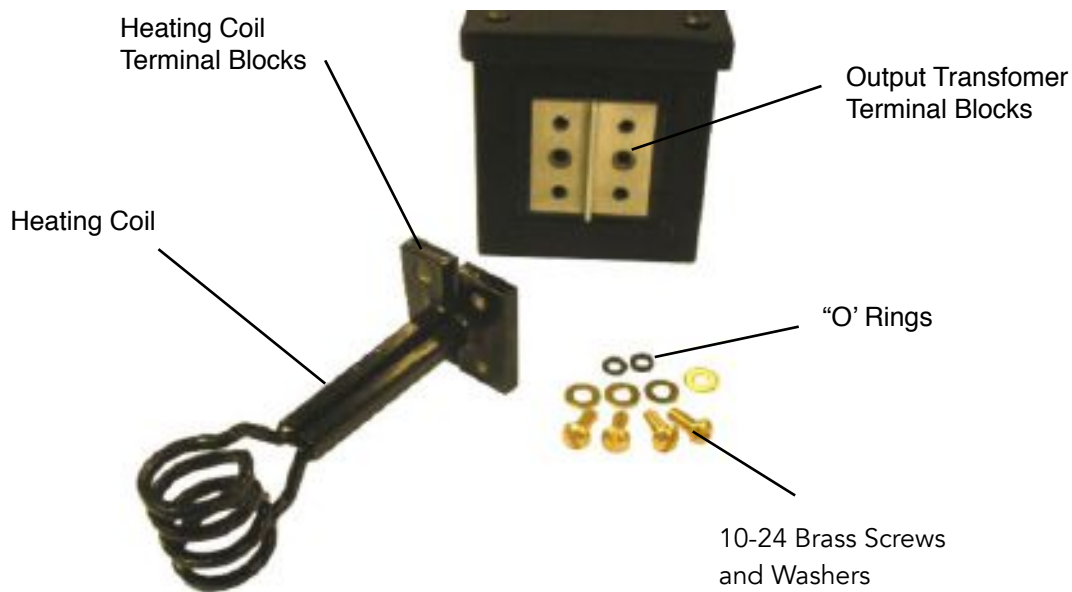

4. SETUP

4.4 HOOKUP THE COOLANT SOURCE

All HeatStation systems require water cooling. If not properly cooled certain components, particularly the heating coil, will rapidly overheat and can be damaged. Coolant can be provided using a recirculating water system, such as the Dynaflux 1100V supplied by Magneforce Inc. or any standard water source that delivers the required pressure and flow rate.

Water is delivered to the power supply, the output transformer and coil via the coolant in/out ports located on the left side of the power supply cabinet. These coolant ports are 1/4" quick connect fittings that accept 1/4" OD semi-rigid tubing. The system is supplied with 12 feet of tubing and all fittings needed to connect to a recirculating water system or in house water source.

The minimum water flow required is .35 gpm at a minimum pressure of 40 psi and a maximum pressure of 100 psi. The maximum acceptable water temperature is 100°F. The water should be clean and free of particulate contamination. Excessive contamination could clog internal passages in the power supply, transformer and heating coil.



The coolant flow paddlewheel on the side of the power supply spins when coolant is flowing through it. The spinning paddlewheel sends a signal to the control circuitry of the power supply. When it is spinning fast enough (indicating min. .35 gpm flow) the yellow coolant light on the front panel will turn off and the unit will operate. The paddlewheel must be moving in a clockwise direction. If it is turning in the wrong direction or not spinning fast enough, the yellow coolant light will remain on and the unit will not heat.

A coolant filter should be installed between the coolant source and the Coolant In port on the power supply. The filter is intended to trap and particulate matter or sediment that might clog up the system over time. The recommended filter is Magneforce P/N 22620. This filter is also supplied with all fittings required for hookup.

4. SETUP

4.4 COOLANT REQUIREMENT AND HOOKUP (cont'd)

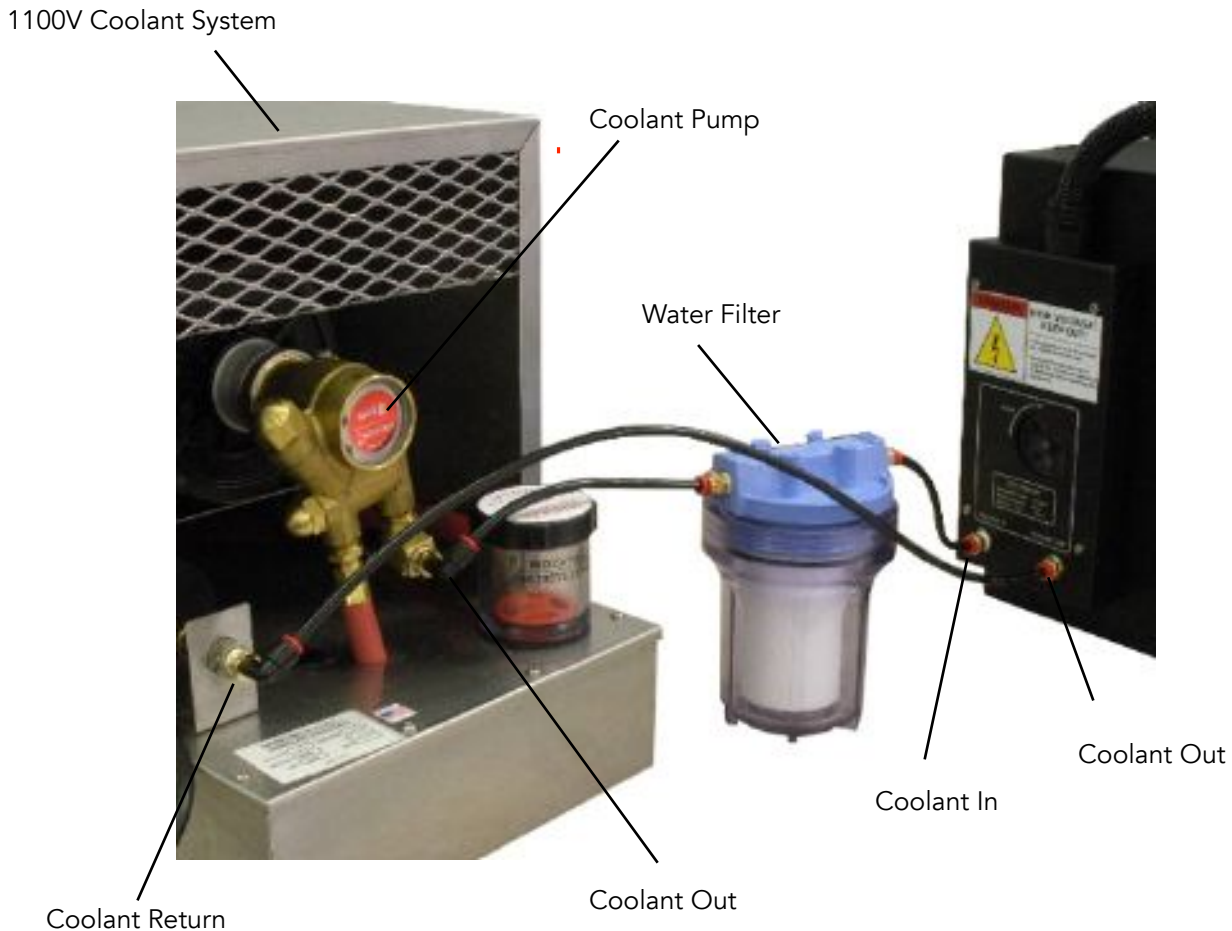

HeatStation HS5000R2 setup with 1100V Recirculating Coolant System and Water Filter

4.4.1 Recommended Coolant

The recommended coolant to be used with HeatStation systems is a mixture of 75% deionized water and 25% inhibited ethylene or propylene glycol. It can be purchased from Magneforce Inc. as P/N 78640. Distilled or RO water can also be used in place of deionized water.

Note: 100% RO or distilled water or tap water can be used for short periods of time but it will contribute to corrosion of metallic elements in the coolant system resulting in clogging in the system fittings and tubing over time.

4. SETUP

4.5. SELECT THE SOURCE FOR POWER CONTROL

The power control (heating level) for the HS5000R2 can be set using either the control knob on the front panel of the power supply or by a user supplied power control signal supplied using the auxiliary remote cable. It can not be both. There is a selector switch located on the Main Logic Control Board located inside the power supply. If this switch is in the DOWN position, the control knob on the front panel of the power supply is active. If it is in the UP position, a user supplied 0 to +10Vdc control signal is required. The switch is shown in the picture below.

NOTE: If the switch is in the UP position and a user supplied 0 to +10Vdc is not supplied, the system will still turn on and heat but only at a very low soft start power level.

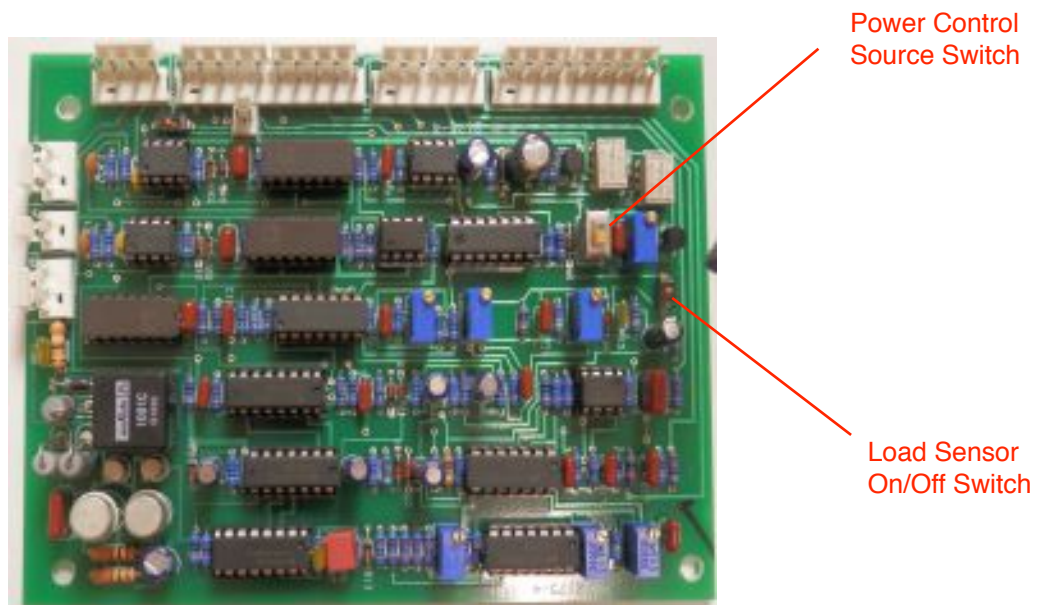

4.6. ATTACH THE CONTROL UNIT

The operation of the HS5000R2 power supply is achieved using standard operating controls supplied by Magneforce Inc. or by user supplied controls, such as a simple SPDT on/off switch or a PLC controlling cycle time and output power. The HS5000R2C does not require any additional controls for basic operation. In many setups, however, a on/off pushbutton unit or twin footswitch is used to turn heating on and off remote from the power supply. The different types of control units available include:

- 4.6.1. Auxiliary Remote Cable
- 4.6.2. On/Off Pushbutton Station
- 4.6.3. Twin On/Off Footswitch
- 4.6.4. Power Control Footpedal (HS5000R2 only)
- 4.6.5. Timer/Power Control (HS5000R2 only)

The various types of control units all plug into the remote jack on the right side of the power supply.

4. SETUP

4.6.1 Auxiliary Control Cable

The auxiliary remote cable can be used to control the operation of both the HS5000R2 and the HS5000R2C. It can be used to turn the heating cycle on and off and to control the heating power. It also provides a signal from the power supply that indicates the actual operating power level, either as a DC voltage or as a relay output. This signal can be used by a PLC to verify that heating is consistent from part to part.

In most applications the auxiliary remote cable is used with the HS5000R2 power supply. This system requires user supplied control signals and is most suitable for use as part of a larger system. It can also be used with the HS5000R2C. The same cable can be used for both power supplies. However, wiring connections when used with the HS5000R2C are different. The setup of the cable for use with both systems is described below.

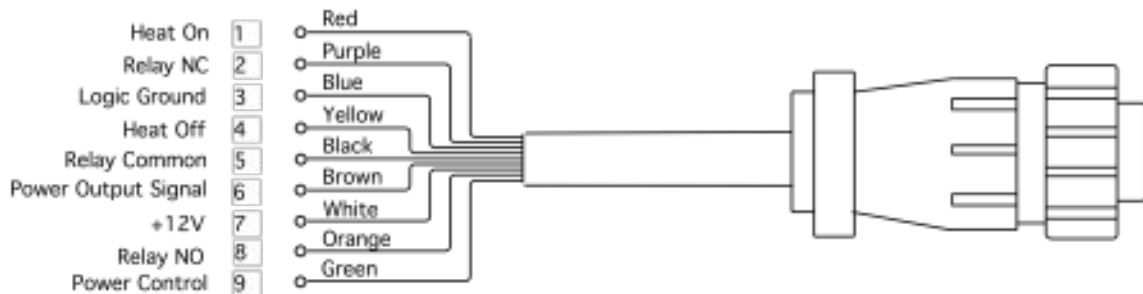

4.6.1.1 On/Off Control (HS5000R2)

To turn heating on and off, connect wires 1,4 and 7 to a SPDT operator. Wire 7 (+12V) should be connected to switch common. Wire 1 (Heat On) should be connected to the NO contact and Wire 4 (Heat Off) should be connected to the NC contact. Closing the contact between wires 1 and 7 will start heating, turn on the HEAT ON light and turn off the HEAT OFF light. Opening the contact will stop heating.

4.6.1.2 On/Off Control (HS5000R2C - REM ON Selected on Control Panel)

The heat on/off function of the HS5000R2C is controlled by the timers. It can be activated using the START pushbutton on the control panel or via a remote operator (REM ON must be selected on the control panel). To turn heating on, connect Wire 1 (Heat On) and Wire 7 (+12) to a NO open momentary switch. Connect wire 4 (Heat Off) and Wire 3 (Ground) to a second NO momentary switch. Pressing the switch for Heat On will start the timer(s) and heating will begin. Heating will continue until the timer(s) time out. To stop heating and reset the timers before the end of the timed cycle, press the switch for Heat Off. (or the Heat Off button on the control panel).

4.6.1.3 Vdc Power Output Indicator

A voltage signal of 0 to 5 Vdc is supplied at wire 6. This signal can be used by an analog input card on a PLC to verify consistent operating power from cycle to cycle. A voltage signal of 2.5V indicates 50% power, 3.75V indicates 75% power etc.

4. SETUP

4.6.1.4 Relay Output Verification

A relay output is provided at wires 2(NC), 5(C) and 8(NO). This relay will energize when output power exceeds a preset level set by a potentiometer on the main control board (see picture in Sect. 4.5). This potentiometer is set to trip the relay at 30% power. The purpose of the relay output is to verify that heating is active and has not been interrupted by a blown fuse, coolant flow problem etc.

4.6.1.5 Heating Power Control (HS5000R2 Only)

Power control is achieved by supplying a 0 to +10Vdc signal between wires 3 (ground) and 9 (+Vdc). This signal could be supplied by an analog PLC output, a temperature controller or similar device. A signal of 0 volts will result in minimum, "soft start" power. A signal of 10.0 volts DC will result in maximum output power. Do not apply a control voltage in excess of 10.0 volts. This could cause the power supply to operate at too high a power level and could cause damage to the power supply.

Note: The power source selector switch (See Sect 4.5) must be in the UP position for remote power control.

Note: It is possible to use a remote power control signal using the HS5000R2C power supply. However, the signal will be independent of the timers. If used on a HS5000R2C the timers should be set at an artificially high value (e.g. 999.9 seconds) and on/off control achieved by turning the timers on and off as described in Sect. 4.6.1.2.

4.6.2 On/Off Pushbutton Station

The on/off pushbutton station can be used with either the HS5000R2 or the HS5000R2C. When used with the HS5000R2 it must be used in combination with the timer/power control unit (Sect 4.6.5) Plug the cable on the on/off pushbutton station into the jack on the bottom of the timer/power control. Pressing START will start the timer and the heating cycle. Pressing STOP will reset the timer and stop the heating cycle.

When used with the HS5000R2C the on/off pushbutton station is used to remotely start the timers and heating cycle on the HS5000R2C front control panel. REM ON must be selected on the control panel. As above, pressing START will start the timer(s) and heating. Pressing STOP will reset the timers and stop heating.

NOTE: The internal wiring of the on/off pushbutton station is different depending on if it is to be used with the R2 or R2C unit. This should be specified at the time of purchase .



To Timer (HS5000R2)

To Power Supply (HS5000R2C)

4. SETUP

4.6.3 Twin On/Off Footswitch

The twin on/off footswitch operates the same as the on/off pushbutton unit described in section 4.6.2. It is often used where it is necessary to position parts by hand, allowing heating to be initiated with the footswitch.

Like the on/off pushbutton, the internal wiring of the twin footswitch is different depending if it is to be used with the R2 or R2C unit.



Twin Footswitch

4.6.4 Power Control Footpedal (HS5000R2 Only)

The power control footpedal plugs directly into the remote jack on the right side of the power supply. It can be used only on the HS5000R2 power supply. The power control footpedal allows the operator to turn on heating and to control the level of heating power by foot, the same as using an accelerator pedal in a car. This allows a great deal of heating control for manual heating operations that are dependent on operator control.

To use the power control footpedal the power source selector switch on the main control board inside the power supply must be in the UP position. (See Sect. 4.5).



Power Control Footpedal

4.6.4 Timer/Power Control (HS5000R2 Only)

The timer/power control provides the capability to set the heating power and cycle time remote from the main unit. Cycle time, interval and operating mode are set using the timer thumbwheel switches. The first switch sets the operating mode. This should be set on C. The next three switches set the time and the last switch sets the time interval. The time interval is typically set on either S or .S. (Seconds or tenths of seconds)

It is only used with the HS5000R2 standard unit. The timer also includes an LCD readout that displays (in bar graph form) the amount of time remaining in a heating cycle. The timer setting must not be changed in the middle of a heating cycle. This could damage the timer. The timer will automatically reset at the end of a timed cycle or when the off pushbutton or footswitch is pressed.

The heating power is set using the 2 digit pushbutton power control potentiometer. Set the desired output power between 0 and 99%.

4. SETUP

4.6.4 Timer/Power Control (cont'd)

To use the timer/power control unit, plug the 6' grey cable with the jack on the end into the remote jack on the right side of the power supply. Attach an on/off control to the remote jack on the bottom of the timer/power control. This could be a twin footswitch, on/off pushbutton or remote cable. Press the on switch to start heating for the set time and power. Press the off switch to reset the time and stop heating. Heating will stop at the end of the timed cycle if the off switch is not pressed.

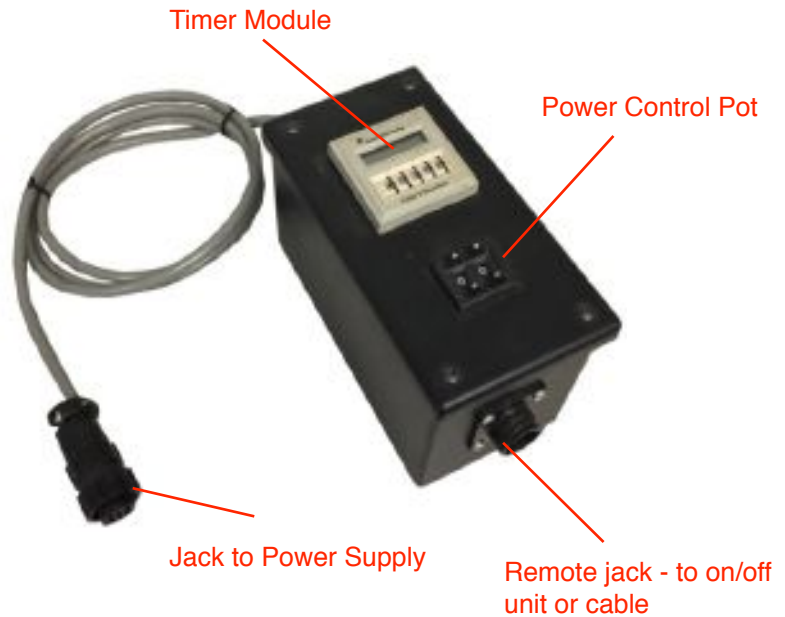

Timer/Power Control Unit

4.7 CONNECT INCOMING POWER

4.7.1 HS5000R2 Power Supply

The HeatStation 5000R2 and R2C power supplies are set up to operate on 208V 50/60Hz 3 phase wye power with grounded neutral. Maximum amperage draw at full power is approximately 20A per phase (not PFC). A 30A service is recommended. The units are supplied with an 8' 4 wire power cord with NEMA L1830 Twist Lock plug. The units are also able to be operated on 240V 3 phase systems (with ground) or on 208-240V single phase systems. For these configurations the appropriate plug, connection is to be supplied by the user.

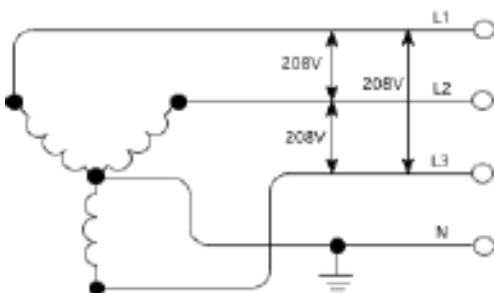

208V Wye 3ph Supply

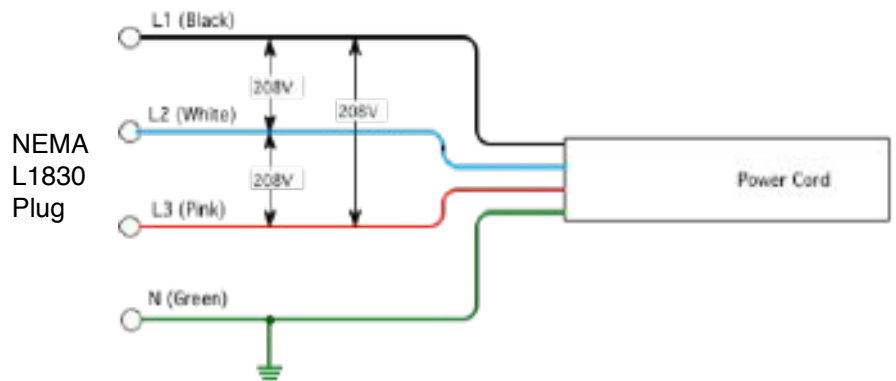

Standard L1830 plug/cord Configuration

4. SETUP

4.7 Connect Incoming Power (cont'd)

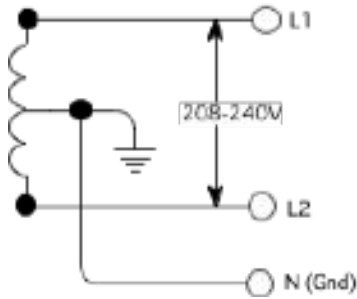

208-240 1 ph supply
Grounded neutral

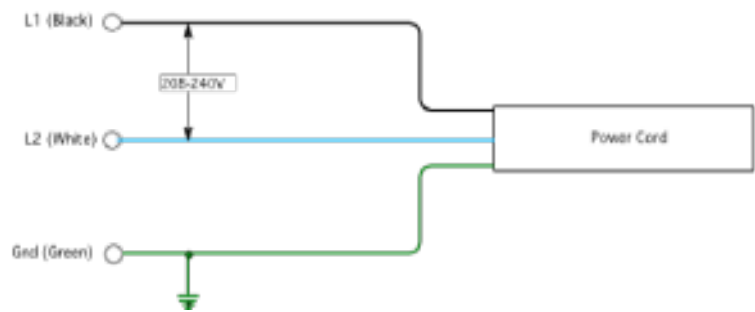

208-240V 1ph connection to power supply
(Pink wire not used)

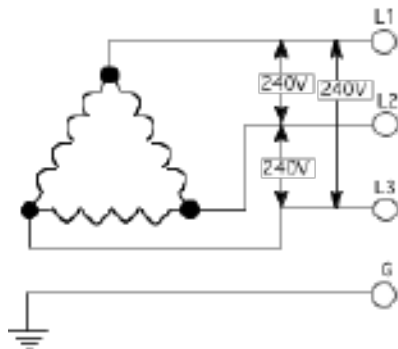

240V Delta w/gnd

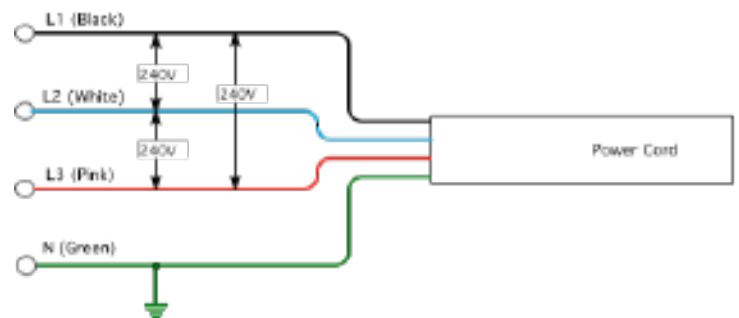

240V 3ph to power supply

4.7.2 Dynaflex 1100V/2200V Coolant Systems

Both the Dynaflex 1100V and 2200V operate on 208-240V 1 phase power. The amperage draw for the 1100V is approx. 2.8A. The amperage draw for the 2200V is 4.1A. (Note: 120V versions are available.) Note: There is a 208-240V receptacle mounted on the right side of the HS5000R2 power supply. This receptacle is provided for plugging in a 208-240V 1ph Dynaflex coolant system. See the picture at the bottom of page 19.)

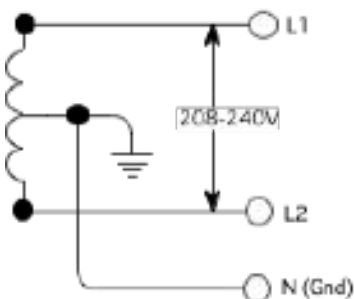

208-240 1 ph supply
Grounded neutral

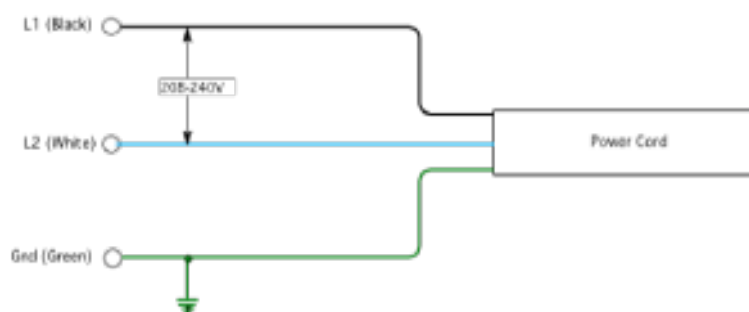

Standard wiring connection for Dynaflex coolers

5. OPERATION

The steps required to operate the HeatStation system are listed below.

- 5.1 Turn on the Coolant Source
- 5.2 Turn on the Power Supply
- 5.3 Set the Power Setting and the Cycle Time
- 5.4 Set Remote On/Off and Timer 2 On/Off
- 5.5 Start heating
- 5.6 Panel Indicator Lights

5.1 TURN ON THE COOLANT SOURCE

Doublecheck all coolant hookups and then turn on the coolant source to be used with the system. Check for any possible leaks at the power supply and the heating coil. If there are any leaks, shut down the coolant source and correct them.

Check for proper coolant flow by observing the paddlewheel flow indicator on the left side of the power supply. It should be turning in a clockwise direction, at a rate where you can't see the individual vanes of the paddlewheel. In not, check the coolant hookups. If the coolant flow is OK, the yellow COOLANT light on the control panel of the power supply will be OFF when the power supply is turned on.

5.2 TURN ON THE POWER SUPPLY

The power supply is turned on using the on/off switch that is located on the right side of the power supply cabinet. This switch is also a fast trip magnetic circuit breaker.

When the switch is turned to the ON position, power on will be indicated by red Heat Off LED and the KW display 3 digit LED on the HS5000R2 control panel or by the Timer Display and KW display being illuminated on the HS5000R2C display. (Note: The yellow COOLANT light should be off. If it is on, check that the coolant source has been turned on and is operating properly.)



Coolant Flow Paddlewheel must turn clockwise



On/Off Circuit Breaker Switch

Auxiliary Power Receptacle for Coolant System

5. OPERATION

5.3 SET THE POWER AND CYCLE TIME

5.3.1 HS5000R2 Power Supply

For the HS5000R2 power supply, the power level can be set using the power control potentiometer on the front control panel or by using a User Supplied power control via the auxiliary remote cable. The power control selector switch as described in Section 4.5 must be set appropriately.

To set power using the front panel control, turn the knob to the approximate power level required. For example, a setting of 7 will give an output of 70% of the maximum 5000 watts, or 3500 watts. The actual power level will be shown on the LED KW display when the system is heating.

To set power using the auxiliary remote cable, a 0 to 10Vdc signal should be supplied between pin 9 (+V) of the remote cable and pin 3 (ground). (See section 4.6.1.5). A signal of 10V will give maximum power, a signal of 5 volts, 50% power etc.

The heating time is dependent on the controls supplied by the user per Sect. 4.6.1.1.



HS5000R2C Standard Control Panel

5. OPERATION

5.3 SET THE POWER AND CYCLE TIME (cont'd)

5.3.2 HS5000R2C Power Supply

The dual timer/power control panel for the HS5000R2C power supply allows the user to set one or two heating cycle times with the coordinated power control setting. Two timer/power levels can be useful when it is desired to bring a part up to temperature rapidly and then reduce the power level to slow down the rate of heating or to maintain the part temperature for a set period of time. Cycle times can be entered from 0.1 to 999.9 seconds and use of one or both timers can be selected.

First, select if you want to use one timer or both by pressing the Timer 2 ON button in the top right corner of the control panel. If the indicator light is illuminated, Timer 2 is turned on.

To set a time, press the SET button for the desired timer. This will turn on a single decimal point to the right of the active digit for a value to be entered. If that digit will not be used (e.g. the first digit will only be used if the setting will be above 100 seconds) press the SET button again until you reach the digit desired. Then press the ENT button to set the value for that digit. Each time the ENT button is pressed it will increment the value by 1. Once the correct value has been entered, press the SET button again to go to the next digit. Continue in this manner until all digits have been entered. After the tenths setting has been entered, press the SET button. All four digits will flash and the time will be entered. If two time/power levels are to be used, repeat for timer 2.

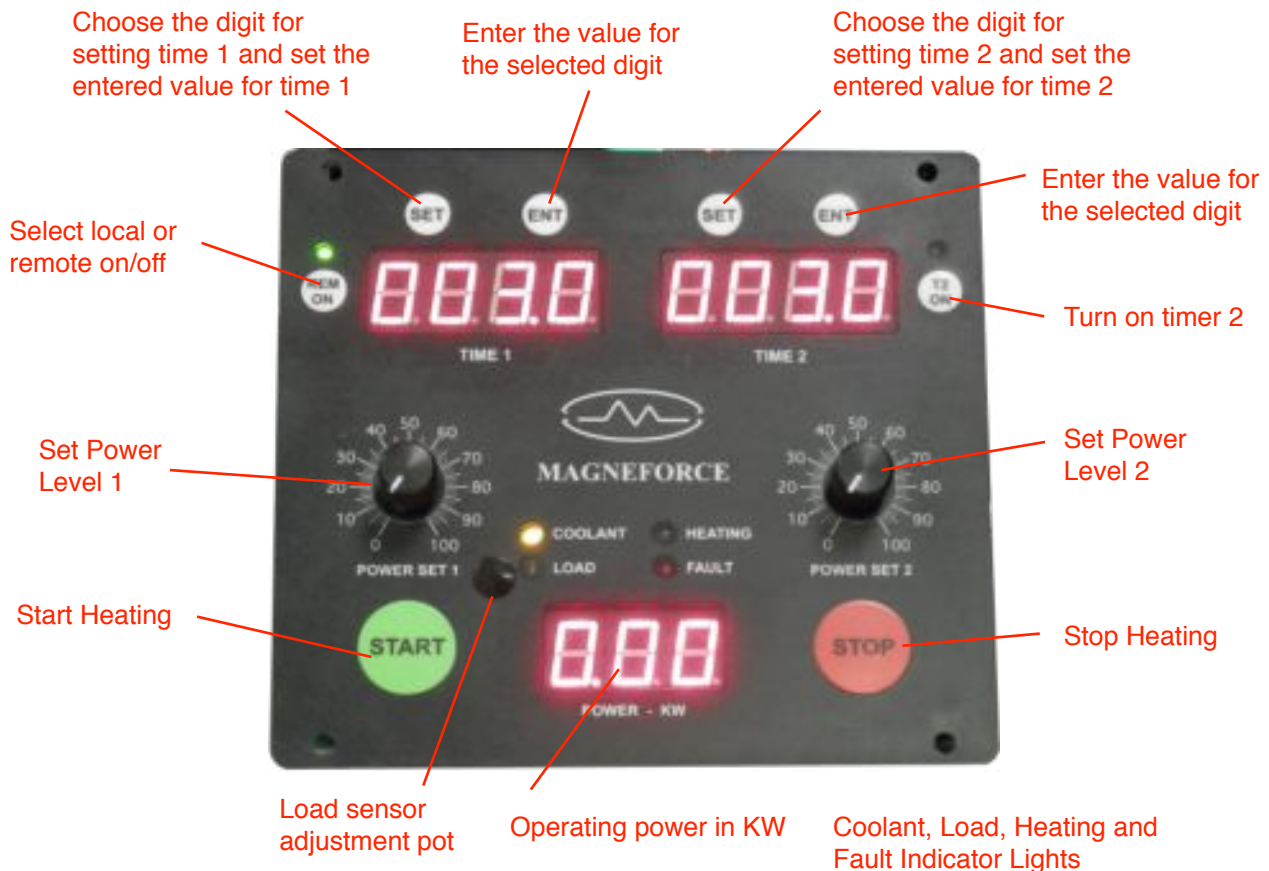

HS5000R2C Control Panel

5. OPERATION

5.3 SET THE POWER AND CYCLE TIME (cont'd)

5.3.2 HS5000R2C Power Supply (cont'd)

For example, to set a value of 5 seconds, proceed as follows:

Press SET. The decimal point to the right of the hundreds digit will turn on. Press SET two more times. This will skip the hundreds digit and tens digit and go to the ones digit. Then press ENT until the ones digit reads 5. Press SET again to go to the tenths digit and press it one final time to skip over the tenths digit and set the value. The display will flash and the LED display will read 005.0 or 5 seconds.

To set the heating power level, the process is basically the same as for the standard control panel. Turn the knob for Power Level 1 to the desired setting. Again, a setting of 7 will give an output of approx 70% power or 3500 watts. If Timer 2 is used set the knob for Power Level 2 in the same manner.

5.4 SET REMOTE ON/OFF AND TIMER 2 ON/OFF

If heating is to be turned on and off using a remote operator, press the REM switch at the top left of the control panel. This will illuminate the REM ON light. In this state, the START button on the control panel WILL NOT DO ANYTHING. Heating can only be initiated from one location. To stop heating, either the STOP button on the unit or the remote STOP can be used.

If Timer 2 is to be used, press the T2 ON on the top right of the control panel. This will illuminate the T2 On light and the heating cycle will automatically continue for the time 2 at power level 2.

When the power supply is first turned on the status of the REM ON function and the T2 ON function can be set using selector switches located on the inside of the control panel circuit board. If, for example, the process will use a remote start operator and only timer 1, these switches will allow these functions to be set correctly at power on.

To change the status at turn on, if required, disconnect power to the power supply, wait 5 minutes for internal capacitors to discharge and open the cabinet door. Locate the selector switches as indicated in the pictures below and move the slide switch for the function required.

Slide switch at top of control panel to change turn on status of T2 ON.

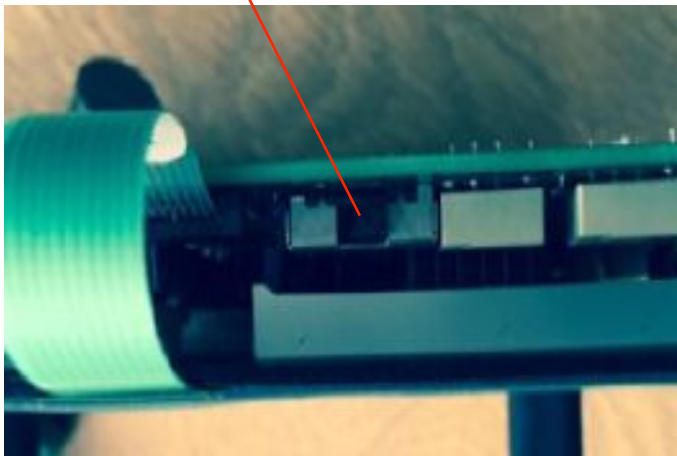

Slide switch on right side of control panel to change turn on status of REM ON.

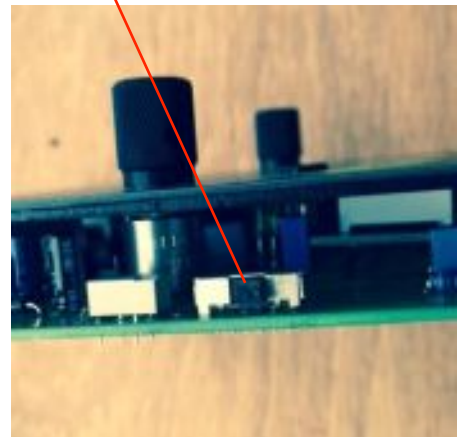

5. OPERATION

5.5 FIXTURE THE PART IN THE HEATING COIL

Before starting to heat, the part must be placed in the heating coil. It should be securely held in position using a clamp or a processing fixture so that the location of the part is constant and to make sure that the part can not touch the heating coil. The location of the part in the coil is important for consistent heating. If the location varies, the part may heat up differently from piece to piece and cycle times could vary.

The part should not be able to touch the coil. Magneforce heating coils are insulated to protect against contact with the part being heated. The type of coil insulation used depends on the application. Direct contact of hot parts with the coil may burn off the insulation coating and expose the copper conductor. Contact between the parts and bare copper on the coil could generate electrical arcs which may damage the power supply.

5.6 START HEATING

5.6.1 HS5000R2 Power Supply

Start heating using the attached control unit or user supplied control connected using the auxiliary remote cable. (Refer to Section 4.6) When heating is initiated, the red HEAT OFF light will turn off, the green HEAT ON light will turn on and the part will begin to heat up. The green LOAD light should be off. (See Section 5.6 below.)

The heating power will be displayed on the KW meter. The power output will be approximately equal to the power setting. For example, if the power control is set to maximum the meter should read approx. 5.0KW. If the power output is less than expected for the setting, the unit may be operating at maximum internal amperage or the load sensor circuit may be holding back power. Meter response time will prevent a true indication of power on very short cycles.

5.6.2 HS5000R2C Power Supply

Select whether heating will be started using the Start button on the control panel or the remote on actuator, depending on which is selected as described in Section 5.4. When heating is initiated, the green HEATING light will turn on and the system will start to heat at power level 1. Timer 1 will start to count down. At the end of time 1, heating will stop (if only time 1 is used) or power will change to the value set for power 2 and timer 2 will begin to count down. At the end of time 2 heating will stop and the timers will reset to their starting value. If it is required to stop heating at anytime during the heating cycle, press the OFF button. This will stop heating and reset the timers.

The heating power will be displayed on the KW meter. The power output shown will be approximately equal to the power setting. For example, if the power control is set to maximum, the meter should read 5 KW. If the power output is less than expected for the setting, the unit may be operating at maximum internal amperage or the load sensor circuit may be holding back power. Meter response time will prevent a true indication of power on very short cycles.

5. OPERATION

5.6 PANEL INDICATOR LIGHTS

Both the HS5000R2 and the HS5000R2C power supplies have indicator lights on the front panel for coolant, load and fault. The purpose of these lights is described below.

5.6.1 Coolant

The yellow COOLANT light indicates whether or not coolant is flowing through the system or if the temperature of the main heat sink inside the power supply is too hot. If the COOLANT light is ON, this indicates that there is no coolant flowing, too little coolant flowing, or that the temperature switch mounted on the main heat sink in the power supply has tripped due to hot coolant temperature. If the COOLANT light is ON, the unit WILL NOT HEAT. The timer may be counting down or the green HEATING light may be ON, but the system WILL NOT HEAT. The COOLANT light must be OFF for heating to take place. If there is an interruption in coolant flow during a heating cycle, heating will stop. It will resume when proper coolant flow resumes.

If the COOLANT light is on, turn on the coolant source and check the flow rate by observing the flow indicator on the left side of the power supply. The paddlewheel must be spinning rapidly and in a clockwise direction. If it is not spinning clockwise, the coolant in and out hoses are reversed. If it is not spinning at all or slowly, check the coolant source and make sure that it is full, turned on and operating at at least 50 psi.

5.6.2 Fault

The red FAULT light indicates that the main semiconductor fuse inside the power supply has blown due to the occurrence of a short circuit fault condition inside the power supply. It also indicates if the DC voltage inside the power supply is too low. If the red FAULT light is on, turn off the power supply and disconnect power. Wait five minutes for internal capacitors to discharge, then open the front door of the power supply and check the fuse. (see the parts illustration in the appendix.) If the fuse is blown, contact Magneforce Inc. for additional information. If the fuse is OK, check the incoming voltage to the unit and make sure it is correct. (See Sect 4.7)

5.6.3 Load

The HS5000R2 and R2C power supplies are equipped with a load sensor circuit that is meant to prevent operation of the unit at full power if there is no part in the heating coil or if the part is too small for the heating coil being used. It will also cause the operating power of the unit to be reduced to a low power level if the part is removed from the coil during the heating cycle. The circuit is calibrated prior to shipment of the system. However, it may require some adjustment depending on the specific coil being used and the part being heated.

When the power supply is first turned on the green LOAD light should be off. The circuit is only active when the unit is on and heating. When heating is turned on, if the load is OK the green light will be off and the system will operate normally. If the light is on the circuit may require adjustment. To adjust the circuit, proceed as follows:

1. Remove the black plug located to the left of the Load light. This will expose the adjustment pot.
2. Set the operating power to 0. Turn on heating with the part in the coil.
 - For the HS5000R2 turn the pot counterclockwise until the green light goes out and then continue to turn it an additional full turn counterclockwise.

Note: In some applications, particularly for small non-magnetic parts, the load sensor function may not respond correctly and better system performance will be realized if it is turned off. There is a small switch on the main control board inside the power supply that enables this. The picture in section 4.5 shows this switch.

6. OPERATING PRECAUTIONS

When using the HS5000R2 system, there are certain precautions that must be observed in order to assure reliable performance and prevent damage to the equipment. Following these precautions will extend the functional life of the equipment and minimize downtime.

6.1 HEATING COILS

The heating coil is an integral part of the output circuit of the power supply. It is also the part of the system that is most likely to be damaged from mechanical abuse or from high temperatures of parts inside or close to it. If the coil is damaged, it will affect heating performance and could cause power supply failure.

6.1.1 Attach the Heating Coil Correctly

When attaching the heating coil, make sure that the terminal blocks on both the heating coil and the output transformer are clean. Do not use any fasteners to attach the coil except those supplied with the system or comparable. These fasteners include 4 10-24 x 1/2 brass round head screws with #10 brass washers. If replacement fasteners are used that are a different length, or if the washers are not used, the coil terminal blocks will not make proper contact with the output transformer and the system will not work properly.

6.1.2 Make Sure the Terminal Blocks are Clean

The terminal blocks on the coil and the transformer **MUST** be clean. Dirty blocks will affect heating and could damage the system. If a coil has been attached to a transformer for a while, oxidation could develop between the contact surfaces. The coil should be removed periodically and cleaned with a Scotch-Brite pad or emery cloth.

6.1.3 Heating Coil Insulation

Heating coils are all supplied with an insulation coating of some type. The primary purpose of the insulation is to prevent the bare copper coil turns from touching each other or from touching the part being heated. Proper insulation is also required for safety of operation. If the system is operated using coils with exposed copper, it is possible that an electrical arc could be generated during heating, either between the leads and turns of the coil or from the coil to the part, particularly if the coil has been bent or damaged in any way. These electrical arcs could damage the power supply.

The insulation coatings used depend on the type of heating coil and the application. The standard coating is a red powder coated electrical epoxy. This coating is good for low temperature applications (less than 500°F) or for applications where contact between the coil and the part is very unlikely. High temperature, plasma spray ceramic coated coils are also used for high temperature applications and where the part may contact the coil. The ceramic coil will handle temperatures over 2000°F. However, the ceramic is somewhat brittle and can crack if the coil is damaged or mechanically impacted. For specialty applications, fiberglass wrap and ceramic inserts may be used.

No matter what type of insulation is used, the system should not be operated if the insulation coating is worn or missing or if the heating coil is damaged in any way. The coils should be re-insulated. Touch up insulation coatings are available or the coils can be returned to the factory for refurbishment.

6. OPERATING PRECAUTIONS

Corroded output transformer terminal blocks need cleaned

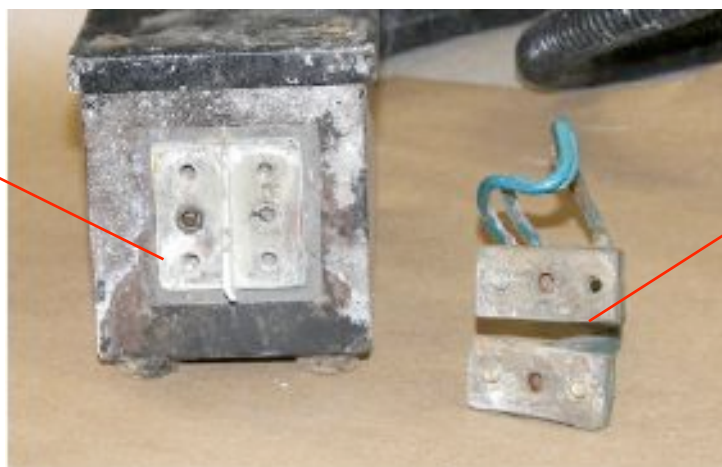

Coil terminal blocks are corroded

6.1.4 Using non-Magneforce coils

All heating coils used with HeatStation systems must be supplied by Magneforce Inc. The design of the coil and how it is matched to the power supply are critical to system performance. The use of any coil not supplied by Magneforce Inc. voids the warranty.

6.2 PRECAUTIONS WHEN HEATING A PART

After heating has been initiated and the part is coming up to temperature, there are a couple of basic precautions that should be observed. These include:

6.2.1 Do not turn on heating unless a part is in the coil

Never turn on heating when there is no part in the coil. This is hard on the power supply and may damage it. Although the power supply incorporates a number of features to prevent problems if this should happen, it is good practice not to let it occur in the first place.

6.2.2 Do not remove the part from the coil during heating

If the part is removed from the coil during the heating cycle, this will cause an instantaneous increase in internal voltage and amperage. In severe cases, it could cause damage to the power supply.

6.2.3 Don't let the part touch the coil

Contact between the part and the coil during the heating cycle can cause arcing and potential damage to the system.

6.2.4 Don't let flux build up around the coil

In brazing and soldering applications where flux is applied to the part, the flux can build up on the coil where it will bridge between the coil turns. Coils used in these conditions should be cleaned regularly.

7. RECOMMENDED MAINTENANCE

Heat Station 5000R2 systems require minimal maintenance. There are a few tasks that should be performed on a routine basis. These include:

7.1 CLEAN THE AIR FILTERS ON THE POWER SUPPLY

The internal components of the power supply are cooled by a fan located on the top right side of the power supply. The intake for the air flow is located on the top left side of the power supply. This opening is covered by foam fan filters to prevent dirt from entering the unit. These filters should be removed and cleaned on a periodic basis.

To clean the filters, take off the plastic fan guard exterior cover. Remove the foam filter element. Wash it out with clean water and dry it off. Replace the filter material and the plastic guard.

7.2 CHECK AND REFILL COOLANT

If a recirculating coolant filter is being used to cool the system it should be checked at least once a week to make sure that the coolant reservoir is filled. Coolant can be lost through condensation or when the heating coil is changed. Dynaflux coolant units supplied by Magneforce Inc. can be refilled using distilled water. If other types of coolant are used, follow the manufacturers recommendations. DO NOT use standard antifreeze. It will gum up the system and restrict water flow.

Over time, particulate matter will build up on the bottom of the coolant system reservoir. This can clog some of the small water paths in the HeatStation system, particularly in the output transformer and the heating coil. We recommend that the coolant system be drained, flushed and refilled every 300 hours of operation. For more information on flushing the system, contact the factory.

7.3 CLEAN TRANSFORMER AND COIL TERMINAL BLOCKS

The terminal blocks on the output transformer and the heating coil should always be cleaned when replacing a heating coil. They should also be cleaned on a regular basis even if the coil is not changed and only one heating coil is used. This is particularly the case when brazing and soldering fluxes are used on the part. These fluxes give off corrosive fumes that can eat at the terminal blocks and leech into the terminal interface.

Use Scotch-Brite pads or fine emery cloth to clean the terminal surfaces. When using emery cloth, be careful not to get any grit in the coolant ports. If the terminal blocks are pitted or badly dinged up they should be resurfaced using a flat file or returned to the factory for possible repair.

7.4 INSPECT THE HEATING COILS

Heating coils should be inspected on a regular basis for signs of mechanical damage or worn insulation. Coil turns and coil leads must not be allowed to contact each other unless there is insulation between them. The insulation on the coil must be intact for functional and safety reasons. Repair the coils and replace the insulation as required. Heating coils can be returned to the factory for repair and re-insulation if required.

8. APPENDIX

8.1 HS5000R2 Exterior Components

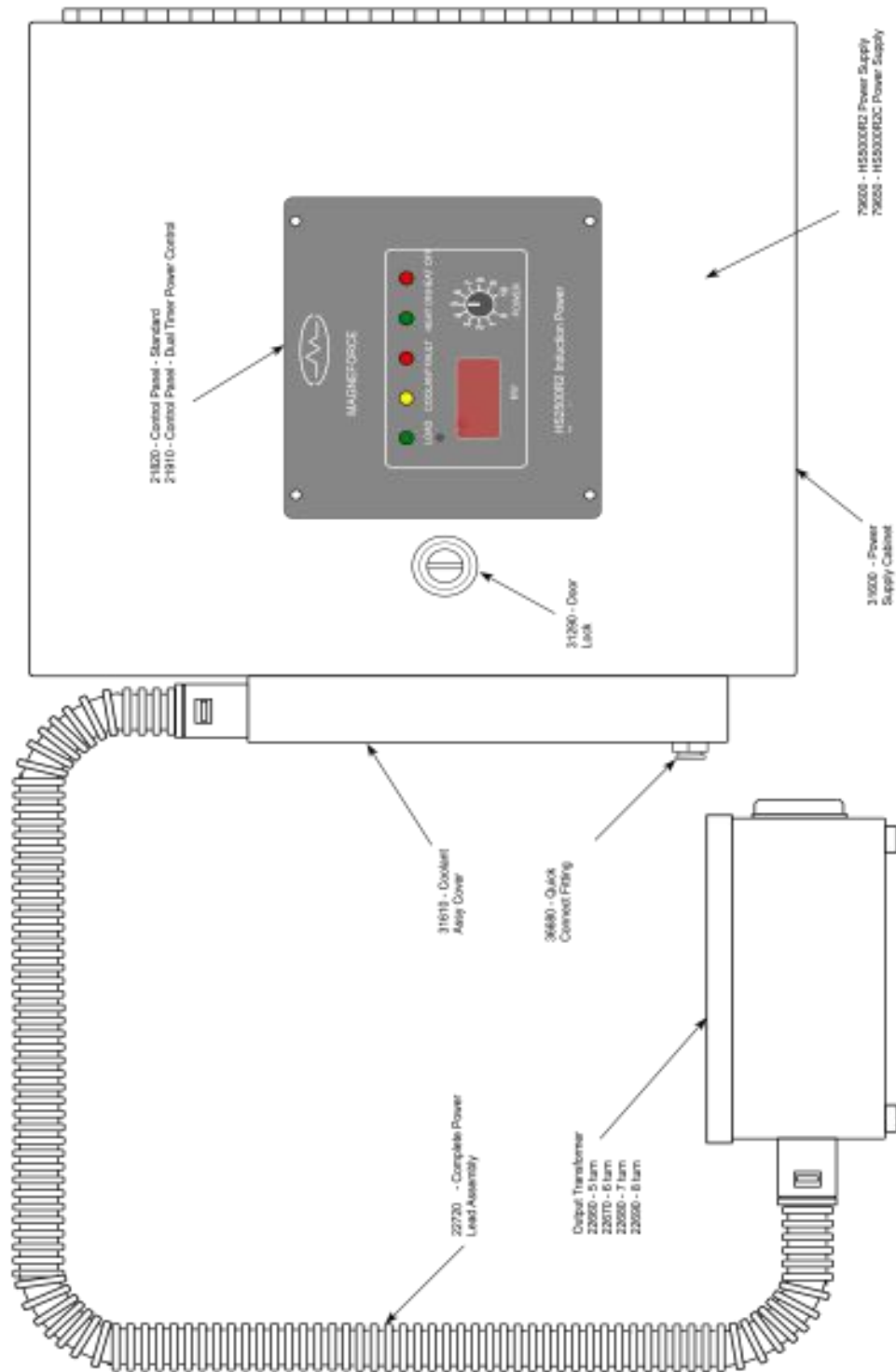

8. APPENDIX

8.2 HS5000R2 Interior Components

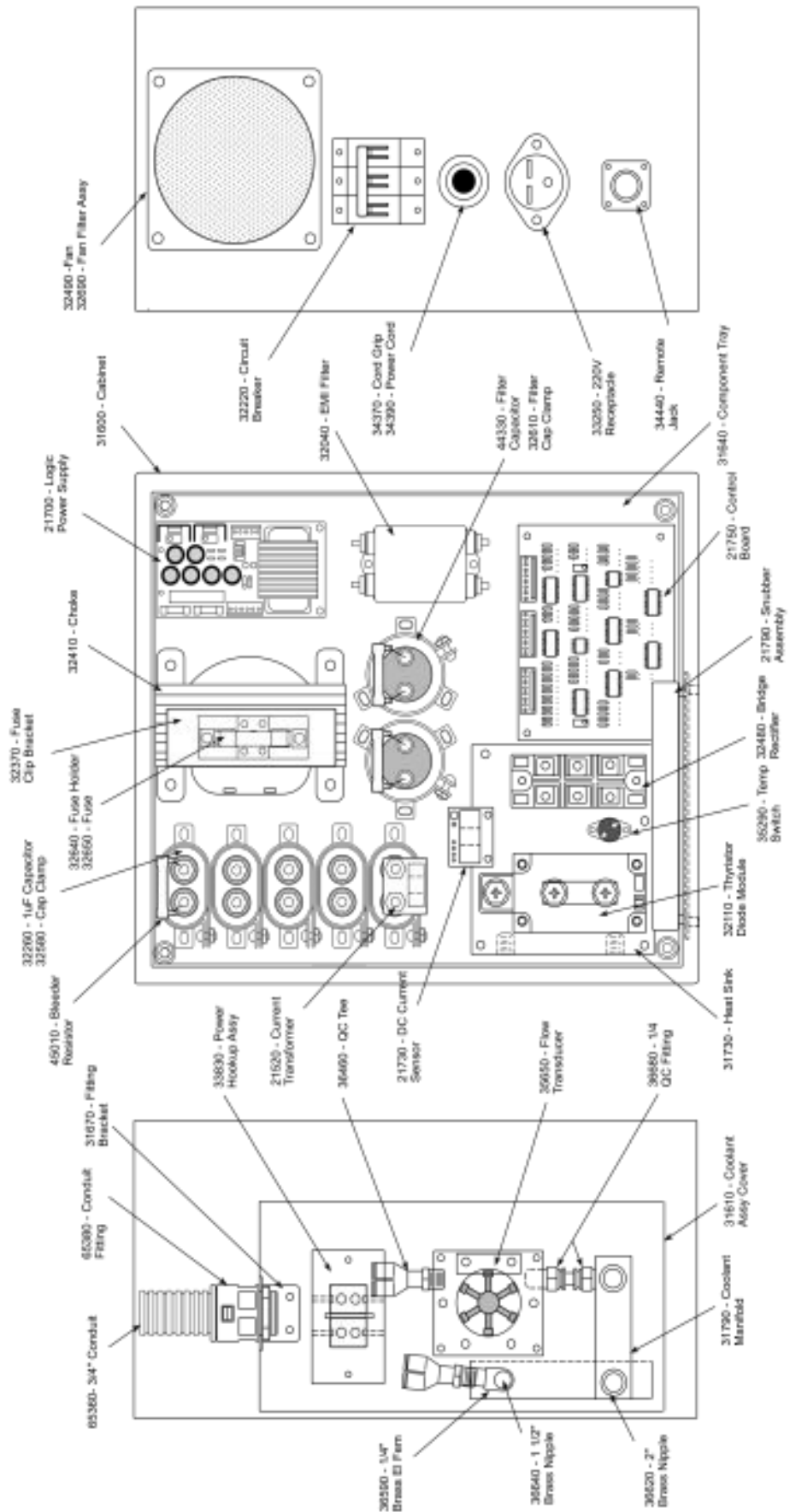

8. APPENDIX

8.3 HS5000R2 Power Schematic

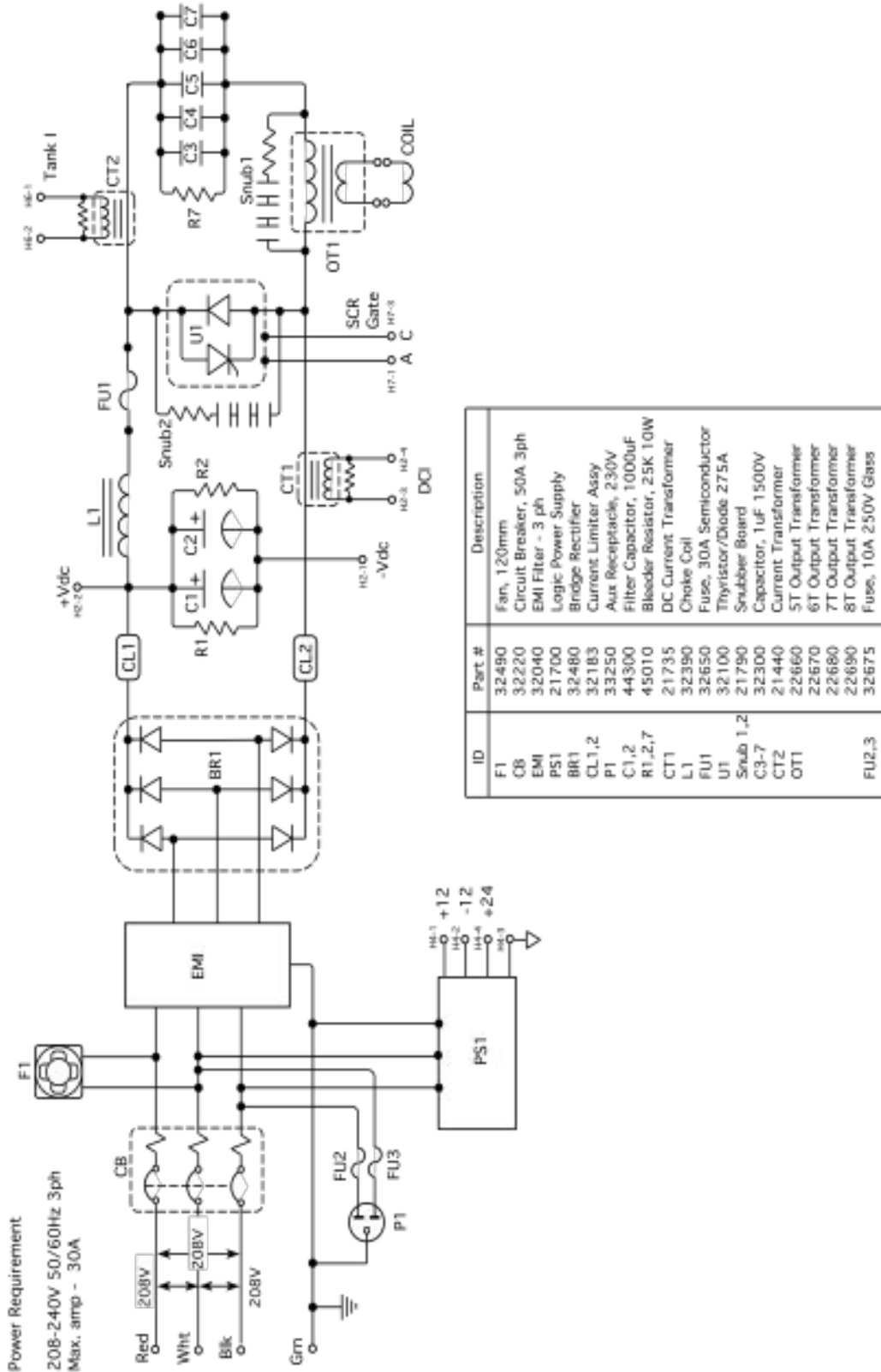

8. APPENDIX

8.4 HS5000R2 Control Wiring

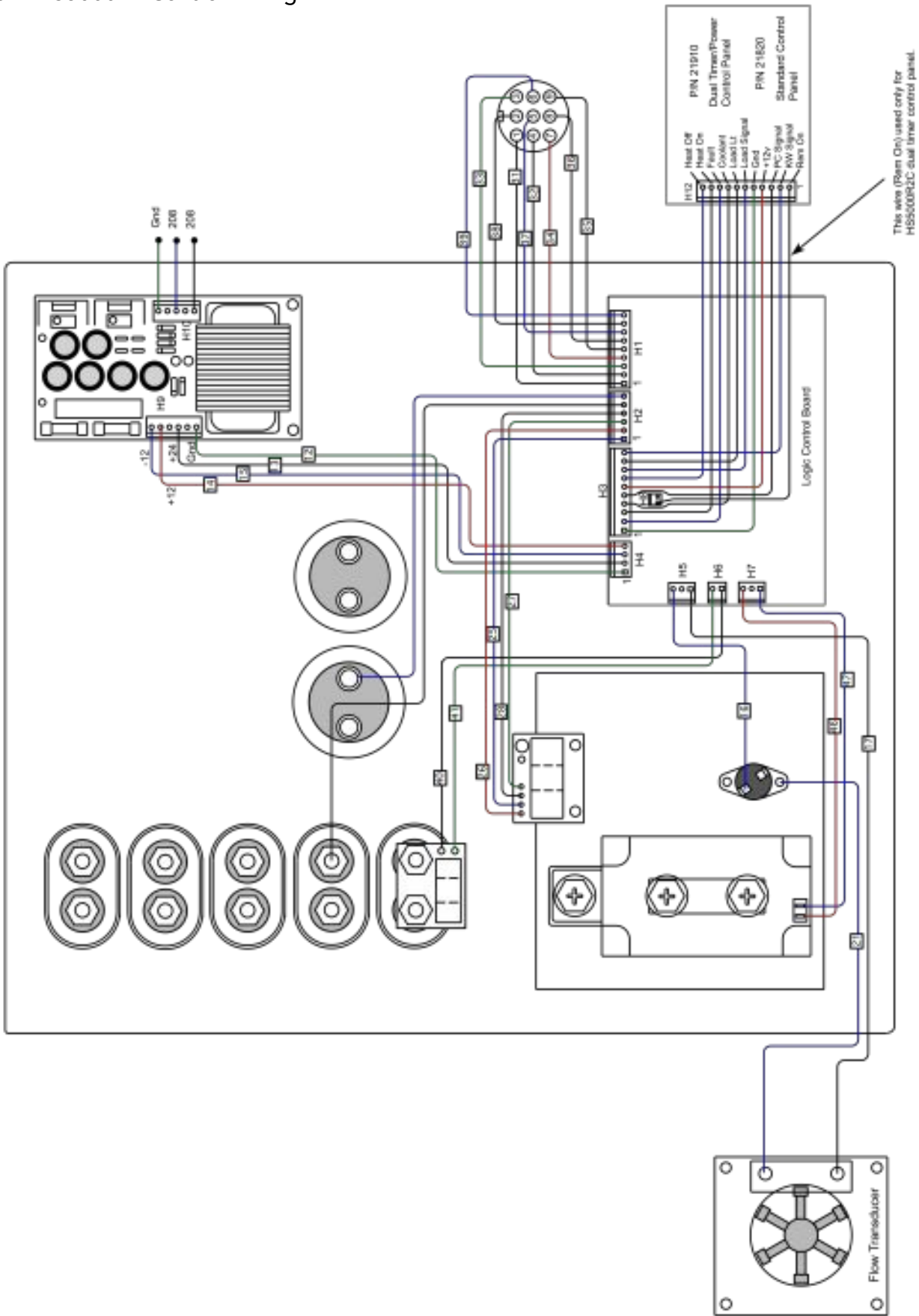

8. APPENDIX

8.5 HS5000R2 Parts List

HS5000R2 & R2C Spare Parts List

P/N	Description	Price
31600	Main Cabinet	\$295.00
31610	Coolant Cover	\$109.00
31640	Component Tray	\$95.00
31690	Hanger Brackets	\$35.00
31660	Filter Cover	\$16.00
31670	Bracket, Power Cable	\$12.00
87120	Rubber Feet	\$0.75
21940	Nameplate	\$5.00
34370	Cord Grip	\$19.75
34390	Power Cord 8'	\$42.00
32220	Circuit Breaker	\$185.00
34440	Remote Jack	\$8.25
33250	220V Auxiliary Receptacle	\$32.00
32690	Fan Filter Assembly	\$8.00
32490	Fan	\$39.50
31290	Front Door Lock	\$26.50
21820	Control Panel Standard	\$195.00
21910	Control Panel Dual Timer	\$495.00
32040	EMI Filter	\$65.00
44330	Filter Capacitor	\$85.00
32610	Filter Capacitor Clamp	\$5.00
32090	Current Limiter Assy 2pc	\$34.00
45010	Bleeder Resistor w/Term	\$6.50
32410	Choke Inductor 20A	\$259.00
32640	Fuseholder	\$26.00
32370	Fuseholder Bracket	\$28.50
32650	Semi-Conductor Fuse 30A	\$15.00
21700	Logic Power Supply	\$135.00
21750	Logic Control Board	\$525.00
21790	Snubber Board	\$119.00
21730	DC I Sensor	\$60.00
21520	Tank Current Transformer	\$39.00
32260	1 uF Load Capacitor	\$75.00
32580	Load Capacitor Clamp	\$5.75
31730	SCR Heat Sink	\$250.00
32480	3 ph Bridge Rectifier	\$165.00
32110	Thyristor/Diode Module	\$347.00
35290	Temperature Switch	\$17.00
35650	Flow Transducer	\$170.00
33830	Power Hookup Block Assy	\$135.00
31790	Coolant Manifold	\$95.00
36640	1/4 x 1 1/2 Brass Nipple	\$4.00
36680	QC Fitting, 1/4ID x 1/4NPT	\$6.95
36460	Nylon Tee, QC, 1/4"	\$7.50
34330	Leather Washer, 1" ID	\$1.00
34410	Plug L18-30 TwistLok	\$44.00
36590	Elbow, 1/4 Fem Brass	\$3.00
36620	1/4 x 2 Brass Nipple	\$2.00
22720	Power Lead Assy HS5000R2	\$265.00
22650	Output Transformer 4T HS5000R	\$1,095.00
22660	Output Transformer 5T HS5000R	\$1,095.00
22670	Output Transformer 6T HS5000R	\$1,095.00
22680	Output Transformer 7T HS5000R	\$1,095.00
22690	Output Transformer 8T HS5000R	\$1,095.00

8. APPENDIX

8.6 HS5000R2 Coolant Flow

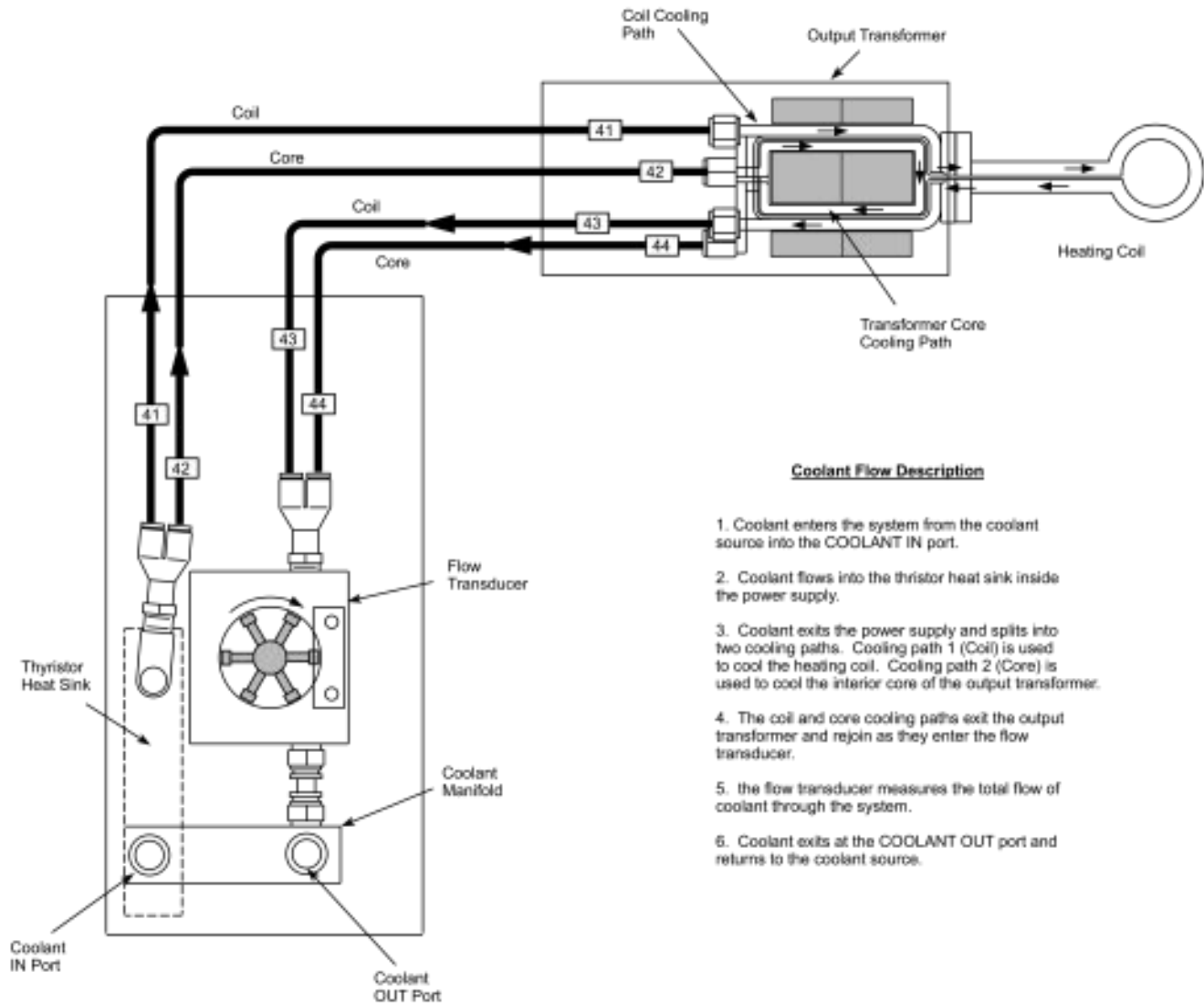

8. APPENDIX

8.7 HS5000R2 Power Supply Dimensions

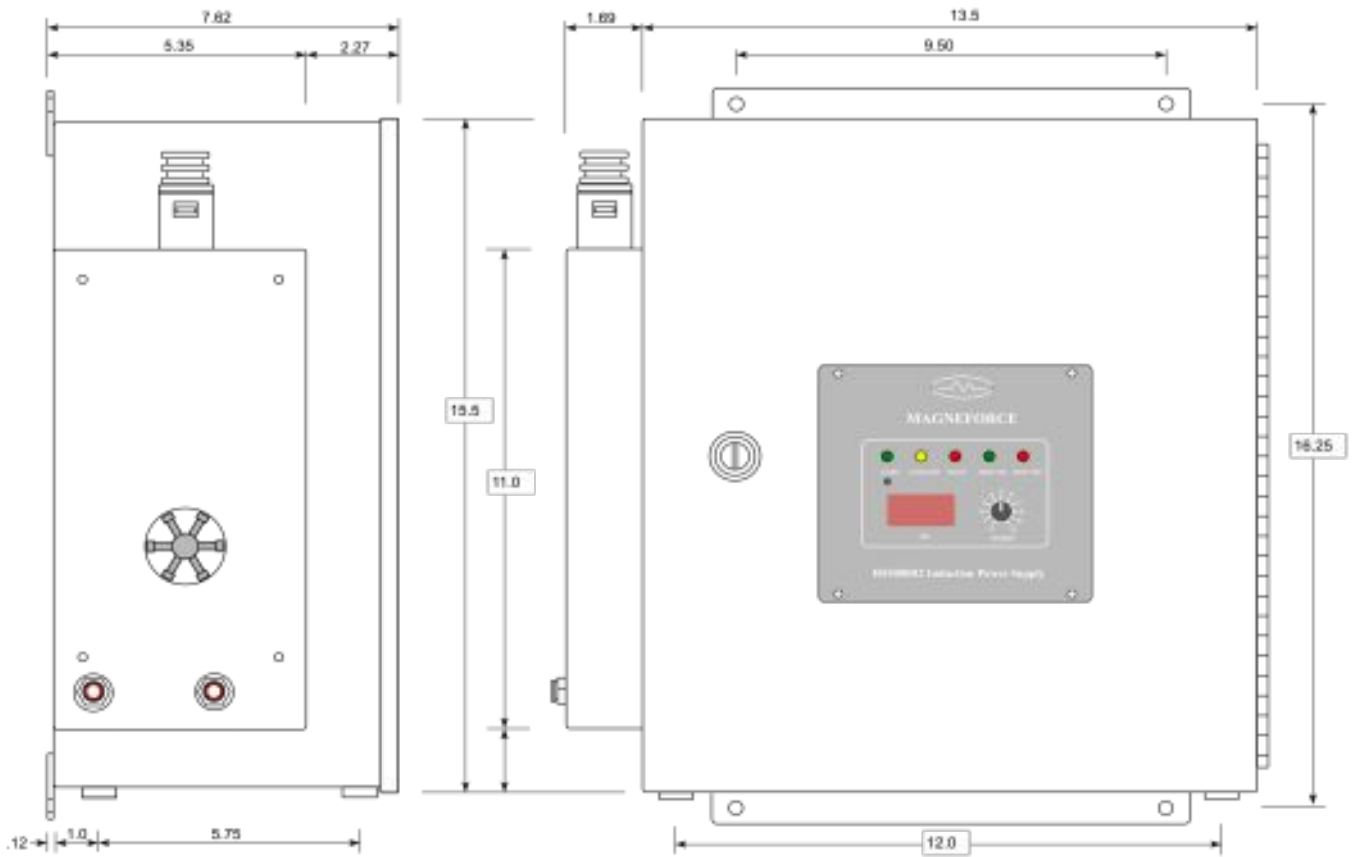

8.8 HS5000R2 Output Transformer Dimensions

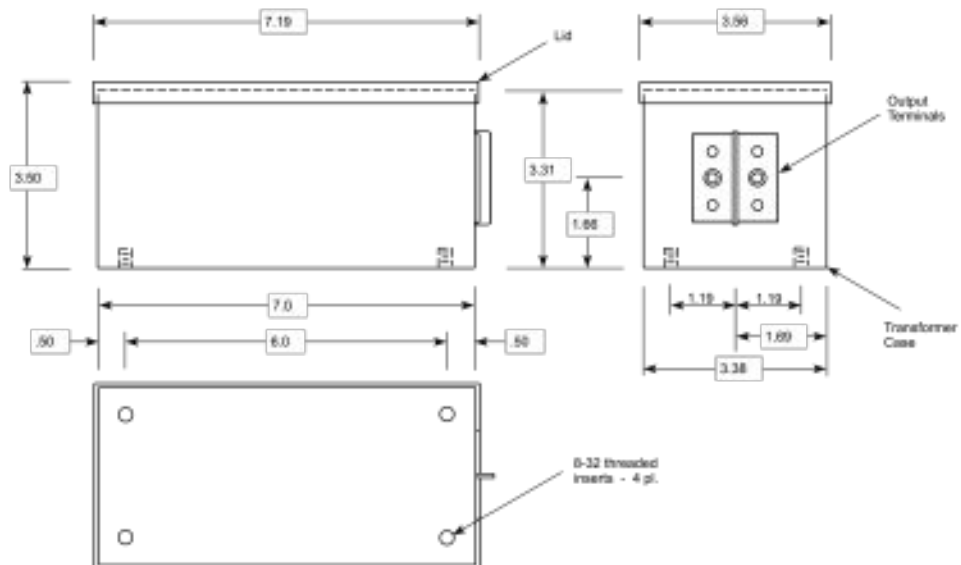

9. WARRANTY

The HeatStation HS5000R2 induction heating system is warranted for a period of one year from the date of shipment. If during this period the equipment fails to operate as originally specified, the purchaser shall notify Magneforce Inc. (the Company) by writing, e-mail or facsimile. The Company will, at its' discretion and as determined by the nature of the reported problem, supply replacement parts to the Customer or provide the Customer a return authorization for the return of the equipment to their factory. The Customer will then return the equipment, freight prepaid, to the Company's facility for verification of the claimed defect. The equipment must be returned in its' original packaging or other packaging suitable to prevent it from damage during shipment. Returned items damaged in shipment will not be accepted. Upon verification of the claimed defect, repairs will be made at no charge to the Customer for labor and/or materials during the warranty period.

This warranty will not apply if:

- The product has been damaged by accident, abuse, misuse or misapplication.
- Any serial number has been removed or defaced.
- The equipment has been serviced by anyone other than authorized personnel.
- Damaged heating coils or heating coils not manufactured by the Company are used.

The Company may use remanufactured, refurbished or used parts in making warranty repairs. The liability of the Company arising out of the supply of its products shall not in any case exceed the cost of correcting the defects as described above and upon expiration of one year from the date of original shipment all such liabilities will terminate. The Company shall not in any event be responsible for special, incidental or consequential damages resulting from any breach of warranty, including lost profits, downtime, goodwill, and damage to or replacement of equipment and property. This warranty does not cover expendable items requiring replacement after reasonable production use. All implied warranties of merchantability and fitness for a particular purpose are limited in duration to one year from the date of shipment.

